



YZ CONNECT

User Manual

Table of Contents

YZ Connect	4
Overview	4
YZ Connect Login/Account	4
YZ-Connect.com	4
YZ Connect via iOS and Android Apps	4
YZ Global Support	4
Hardware	5
Hardware Specifications	5
Dimensions.....	5
Antenna.....	6
Electrical Connections and Wiring	7
N-300 Modbus Settings.....	7
N-400 Modbus Settings.....	7
YZ Connect Overview	8
Selecting an NJEX or ZEO Odorizer	8
Odorizer Management Overview.....	8
Functionality Overview	11
N-300 NJEX Snapshot	11
N-400 ZEO Snapshot	11
Alarms	12
Alarm Log	12
Event Log.....	13
Change Log.....	13
Settings	14
GPS.....	14
Hardware Parameters	15
Reports	16
Graph	16
Tabular	17
Email and SMS History	17
Global Alarm Notifications – Email and SMS	18
Troubleshooting	19
Icon Color and Signal Strength	19
Check Modbus Communication	19
Download Tab.....	20
Frequently asked questions	21
APPENDIX A – Panel Control Drawing	22

YZ Connect

Overview

YZ Connect is a solution for remotely monitoring mission-critical odorization programs. YZ Connect consists of a cellular gateway and a web/app based software that talks Modbus with YZ Systems odorizers. It is a secure, easy, and scalable method to monitor all odorization stations from a single app and/or web interface.

YZ Connect, compatible with both NJEX pneumatic and NJEX ZEO odorizers, communicates with the odorizer via Modbus, pulling a snapshot of data to the cloud every 10 minutes. Grab snapshots faster when needed by selecting the “Get Status” button in the upper left corner of the snapshot page. Remotely monitor all connected odorizers and look at the critical performance parameters from your truck, house, office, or wherever you need to.

YZ Connect Login/Account

The YZ Connect administrator(s) at your company are responsible for adding each user. After your administrator adds a user, the user will receive an activation email from YZ Connect. After following the steps in the activation email, users can login via the website or mobile apps.

Admins should reference the YZ Connect Admin User Manual for details on managing/organizing your company's odorizers, adding employees/customers and more.

YZ-Connect.com

YZ-Connect.com is best accessed using Chrome, Mozilla Firefox, or Microsoft Edge. Other browsers could give diminished performance and are not recommended (i.e. Internet Explorer).

YZ Connect via iOS and Android Apps

Download YZ Connect from the Android or Apple App store.

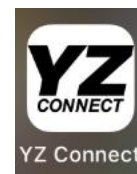

YZ Global Support

24 Hour Service Support:

techsupport@yzhq.com

1-800-NJEX-HELP

Hardware

Hardware Specifications

SAFE AREA ONLY, not approved for installation in Hazardous locations

Installation:	Indoor/Outdoor
Enclosure:	NEMA 4X, IP67
Ambient:	-4° to 140°F (-20° to 60°C)
Electrical:	Single Phase 115/230VAC, 0.55A/0.35A, 50/60Hz
Approval Markings:	ETL (US and Canada), CE, UKCA

Dimensions

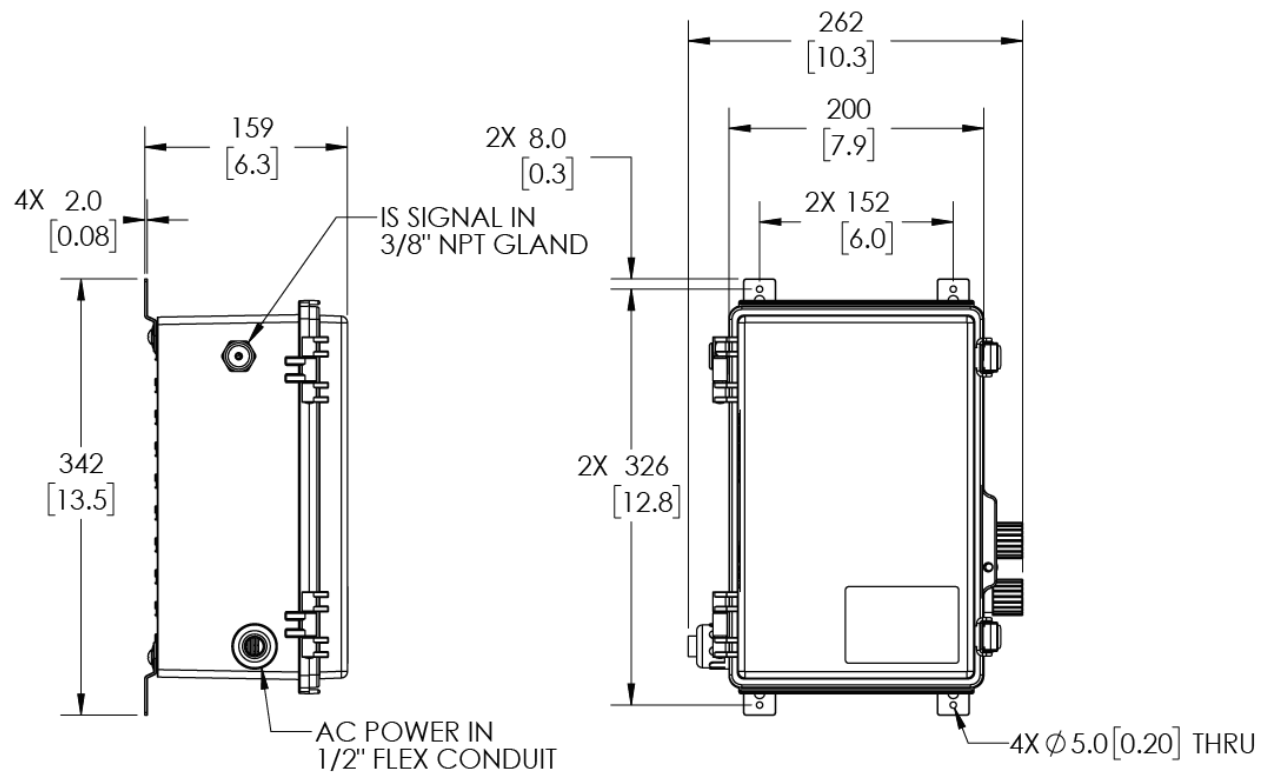

NOTES: UNITS DISPLAYED IN MM [IN]. DIMENSIONS WILL VARY DUE TO NORMAL MANUFACTURING TOLERANCES AND SHOULD BE USED FOR REFERENCE ONLY.

Antenna

The antenna ships separately and should be mounted outside for optimal cellular reception when necessary. To mount the antenna, drill a hole 10-11mm (0.4-0.43") in diam. and mount using the provided nut/washer and foam sticker to maintain the IP rating. Route the two antenna cables through the provided cable glands on the box (labeled Antenna) and hook them up as shown below:

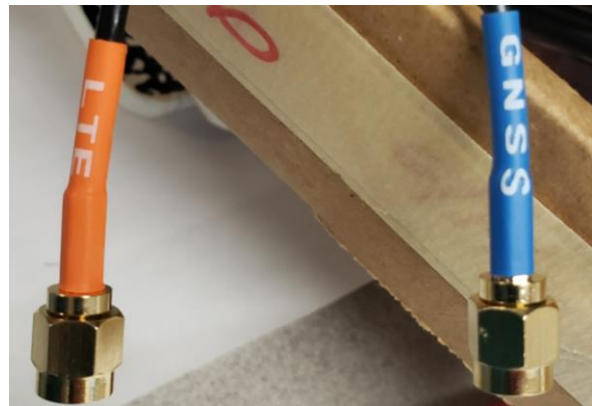
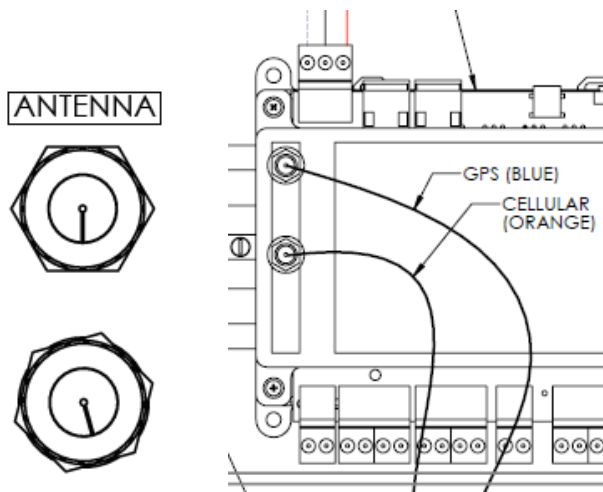
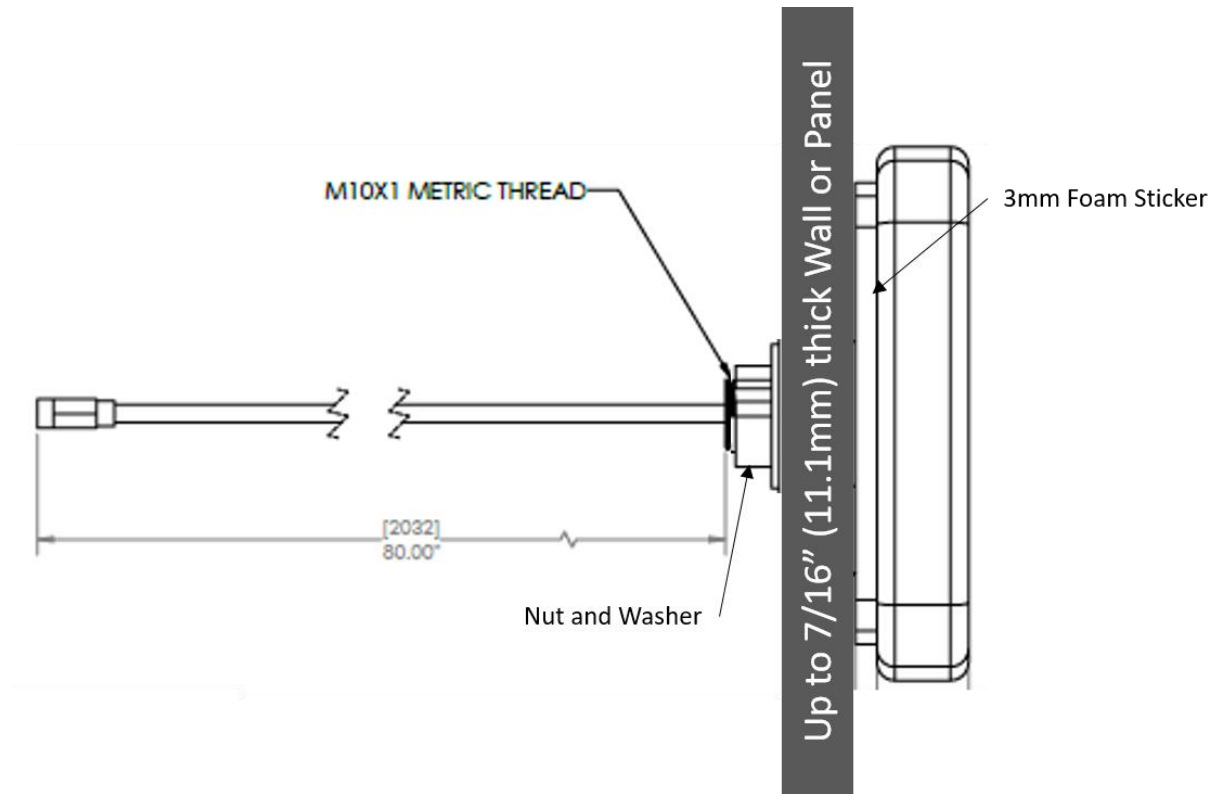

Electrical Connections and Wiring

Reference the panel control document in Appendix A for field wiring requirements.



CAUTION: All wiring should be performed by a licensed professional in accordance with local electrical codes.

Power Supply:

Voltage:	Single Phase 115/230VAC 50/60Hz
Current:	0.55A/0.35A (115/230V)
Required Wire Size:	16AWG (1mm ²)
Wire Terminal Torque:	4.4 lb-in (5 kgf-cm)

Wiring Overview:

Max RS-485 cable length between N-300 or N-400 and YZ Connect Box = 3960ft (1200m)

HAZARDOUS AREA

CLASS 1, DIV 1, GROUPS C-D OR
CLASS 1, ZONE 1, GROUP IIB OR
ZONE 0, GROUP IIB

INTRINSICALLY SAFE WIRING BARRIER: G.M. INTERNATIONAL D1061S-077	
3/8" NPT GLAND CONNECTION	
SIGNAL	BARRIER TERMINAL
RS485-	13
RS485+	14
SHIELD (OPT)	10
AC WIRING IN	
115/230VAC, 0.55/0.35A, 50/60Hz	
1/2" FLEXIBLE CONDUIT FITTING	
1.3 mm ² (16 AWG) WIRE SIZE, 5 kgf-cm (4.4 lb-in) TORQUE REQUIRED	
WIRE	TERMINAL
LINE	L
NEUTRAL	N
GROUND	133.B

NON-HAZARDOUS AREA

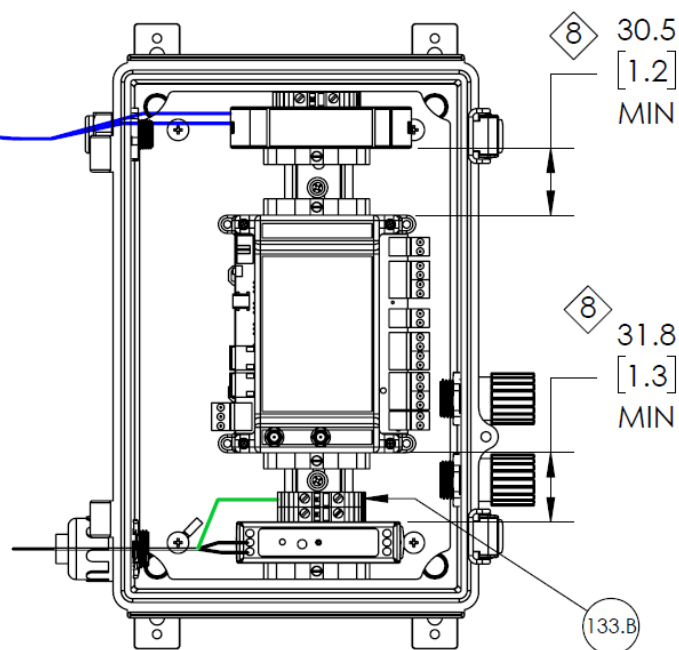

N-300 Modbus Settings

YZ connect uses the default Modbus settings:

- Modbus RTU
- Address = 1
- Baud = 9600
- Parity = None

N-400 Modbus Settings

YZ connect uses the default Modbus settings:

- Modbus RTU
- Address = 1
- Baud = 19200
- Parity = Even
- Stop bits = 1

YZ Connect Overview

Selecting an NJEX or ZEO Odorizer

After logging into YZ connect via www.yz-connect.com or the mobile app, there are two options (map or list) to select an odorizer. Whatever is selected will be the default next time a user logs in.

- Map - select the unit and click the name to view the dashboard
- List - select the unit to view the dashboard
- If you are viewing an odorizer select the  icon to see the list of odorizers again

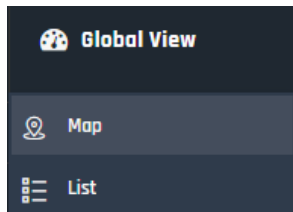

Odorizer Management Overview

Main, Reports and Setup are the three menu options on the top toolbar. Select one to see drop down options. From the mobile app select  to access the menu options for an odorizer.

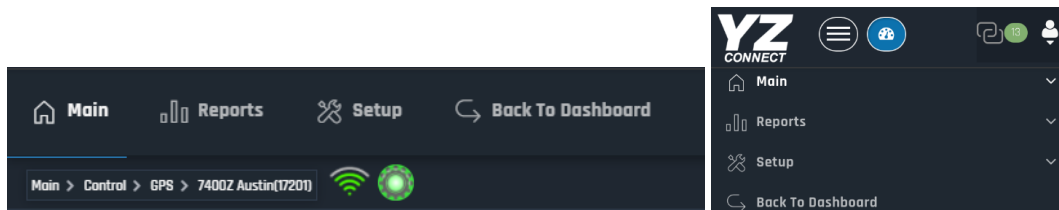

- **Main** – Contains all the critical information about the odorizer

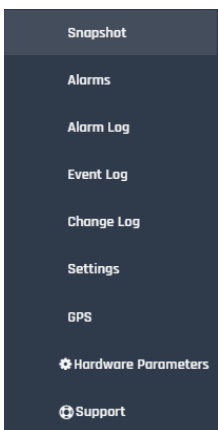

- **Snapshot** – View performance data and select “Get Status” to refresh it.
- **Alarms** – Shows all alarms that are currently active
- **Alarm Log** – Shows a log of all alarms, when they happened, and when they cleared
- **Event Log** – Shows a log of all events and when they happened
- **Change Log** – shows a log of all parameter changes to see what was updated and when
- **Settings** – Displays current parameter settings. Select “Get Settings” to poll the unit to read the current settings.
- **GPS** – Location of this unit on a map so technicians or other employees can locate it.
- **Hardware Parameters** – Configure a 4-20mA odorant sensor, level sensor, or other signal so it can be viewed and logged via YZ Connect.
- **Support** – shortcuts to tech support contact info and the YZ Connect website

Reports – Four different reports are available within the reports tab.

- **Graph** – A Linear or accumulative graph can be selected from the dropdowns above the graph. These graphs are exportable to multiple formats.

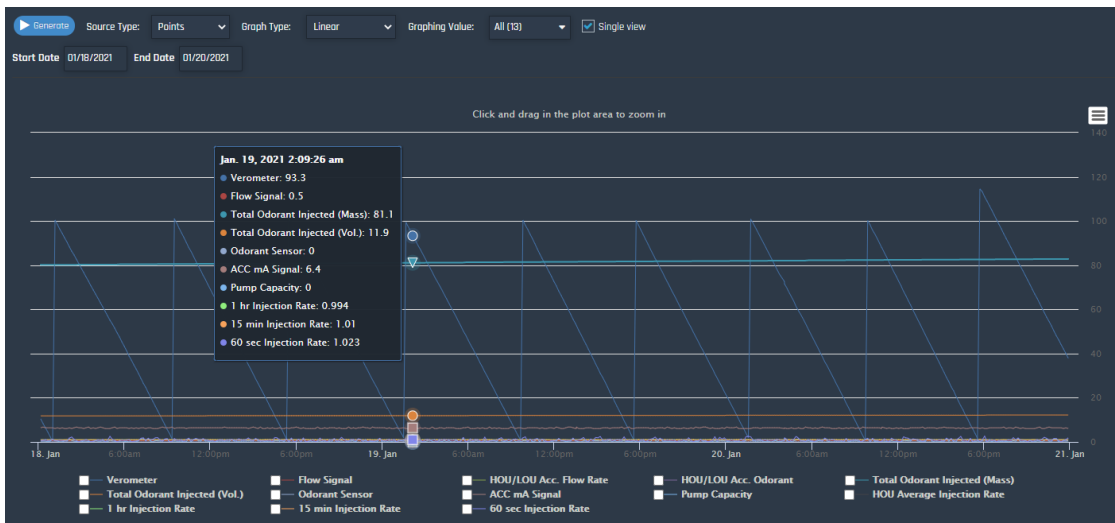

- **Tabular** – Linear or accumulative data can be selected from the dropdowns above the graph. These values are exportable to multiple formats.

Time	Verometer	Flow Signal	Total Odorant Injected (Mass)	Total Odorant Injected (Vol.)	Odorant Sensor	ACC mA Signal	Pump Capacity	1 hr Injection Rate	15 min Injection Rate	60 sec Injection Rate
2021-01-20 11:53 PM	37.9	0.5	82.8	12.2	0.0	6.05	0.5	1.015	0.977	1.054
2021-01-20 11:43 PM	40.1	0.5	82.8	12.2	0.0	6.40	0.4	0.999	0.98	1.055
2021-01-20 11:33 PM	42.1	0.5	82.8	12.2	0.0	6.05	0.5	1.005	1.031	0.575
2021-01-20 11:23 PM	44.1	0.5	82.8	12.2	0.0	6.40	0.0	1.008	1.029	0.096
2021-01-20 11:13 PM	46.2	0.5	82.8	12.2	0.0	6.40	0.1	1.005	1.034	0.607
2021-01-20 11:03 PM	48.1	0.5	82.8	12.2	0.0	6.40	1.4	0.993	0.995	1.534
2021-01-20 10:53 PM	50.2	0.5	82.8	12.2	0.0	6.40	1.4	0.995	0.991	1.566
2021-01-20 10:43 PM	52.5	0.5	82.8	12.2	0.0	6.40	0.3	1.001	0.985	0.719
2021-01-20 10:33 PM	54.5	0.5	82.8	12.2	0.0	6.75	0.3	0.979	1.005	0.831
2021-01-20 10:23 PM	56.4	0.5	82.8	12.2	0.0	6.40	1.3	0.981	0.939	1.614
2021-01-20 10:13 PM	58.5	0.5	82.8	12.2	0.0	6.05	0.7	0.985	0.942	2.11
2021-01-20 10:03 PM	60.6	0.5	82.8	12.2	0.0	6.05	0.0	1.003	1.067	1.295
2021-01-20 09:53 PM	62.8	0.5	82.8	12.2	0.0	6.75	0.4	0.985	0.953	0.639
2021-01-20 09:43 PM	65.0	0.5	82.8	12.2	0.0	6.40	0.5	0.994	0.983	1.071
2021-01-20 09:33 PM	66.9	0.5	82.8	12.2	0.0	6.05	0.0	1.001	1.014	0.543
2021-01-20 09:23 PM	69.0	0.5	82.7	12.2	0.0	6.05	0.0	1.022	1.062	0.304
2021-01-20 09:13 PM	71.2	0.5	82.7	12.2	0.0	6.05	0.7	1.009	0.959	0.703
2021-01-20 09:03 PM	73.3	0.5	82.7	12.2	0.0	6.05	0.1	1.002	0.99	0.112
2021-01-20 08:53 PM	75.4	0.5	82.7	12.2	0.0	6.05	0.5	0.999	0.967	0.543
2021-01-20 08:43 PM	77.5	0.5	82.7	12.2	0.0	6.40	0.0	1.006	1.029	0.665

- **Email History** – View emails sent to the primary and/or secondary emails that are assigned to receive alerts from the device. This report is exportable to multiple formats.
- **SMS History** – View SMS/Text messages sent to the mobile number of the users assigned to receive alerts from the device. This report is exportable to multiple formats.

- **Setup** – Basic diagnostic tools, device customization, and device specific notes.
 - **General** – Basic configuration of the device. This will be configured by your company admin and should not need to be adjusted once set.

- **ID** – This number is the device ID. When requesting support this number will be required. This number cannot be changed.
- **Name** – Up to 20 characters can be used. Model Code or Site Description are most commonly used.

- **Ver & Com** – Displays current Firmware and Cellular module information.

Versions	
VAPOR version	34.42
Hardware version	30.0
Modem version	1.0
RSSI	13
Cell ID	2
SIM	89462046011000667591
IMEI	357298070973861
Last Comm	10/2/2018 5:08:22 PM
Developer Code	6.11

- **Service** – Contains device history. This tab can also be used by service technicians to add notes to the device history such as when a unit was serviced last and what was done. Users must have READ/WRITE enabled in their user settings to add notes.

Functionality Overview

N-300 NJEX Snapshot

View the latest performance data for the NJEX odorizer on this page. View pressures, odorant level, Verometer level, serial #, totalizers, stroke count, and more.

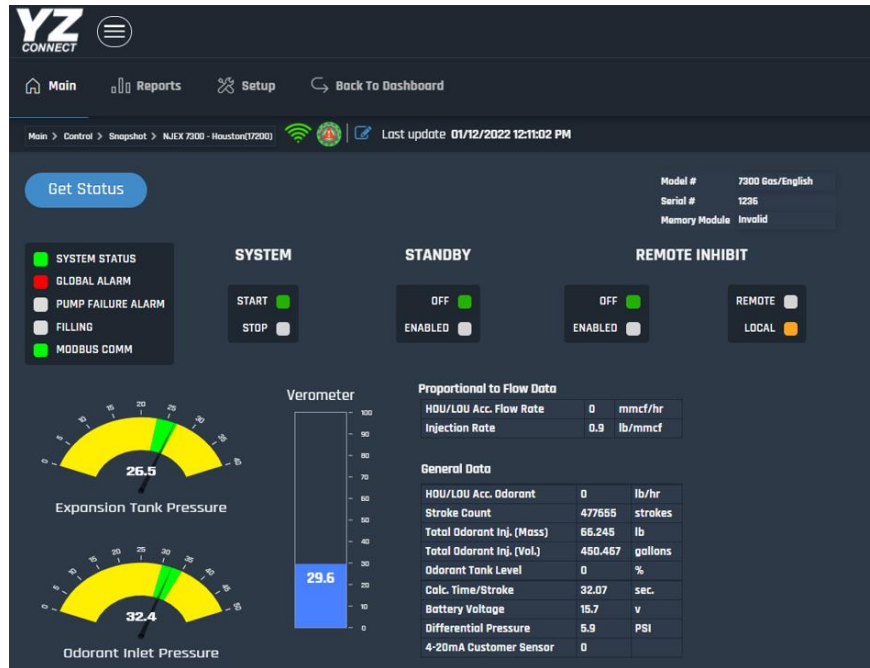

N-400 ZEO Snapshot

View the latest performance data for the NJEX ZEO odorizer on this page. View injection rates, pressures, odorant level, Verometer level, pump performance, totalizers, flow signal, serial #, and more.

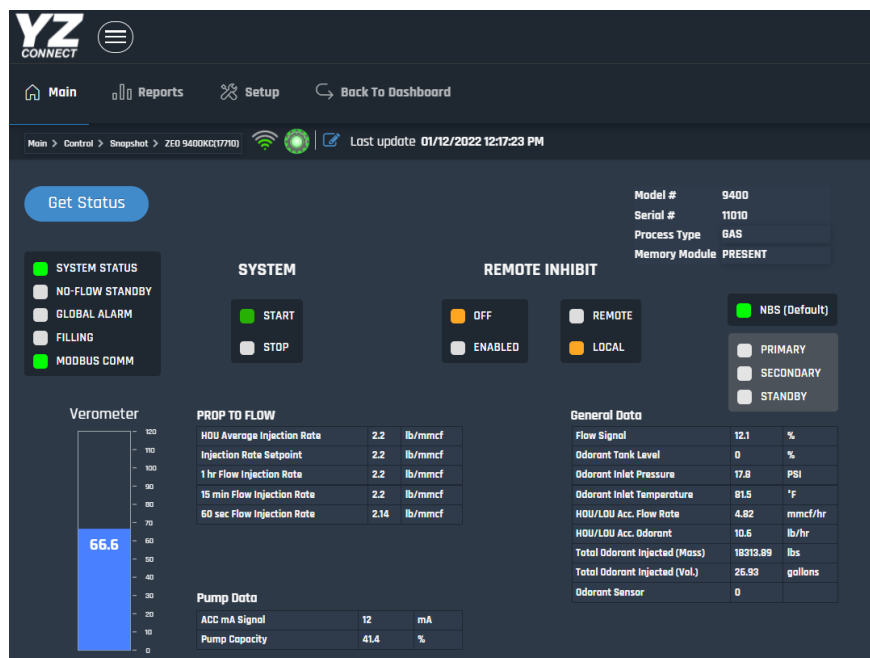

Alarms

View any alarms that are currently active. Active alarms will have a RED box next to the alarm.

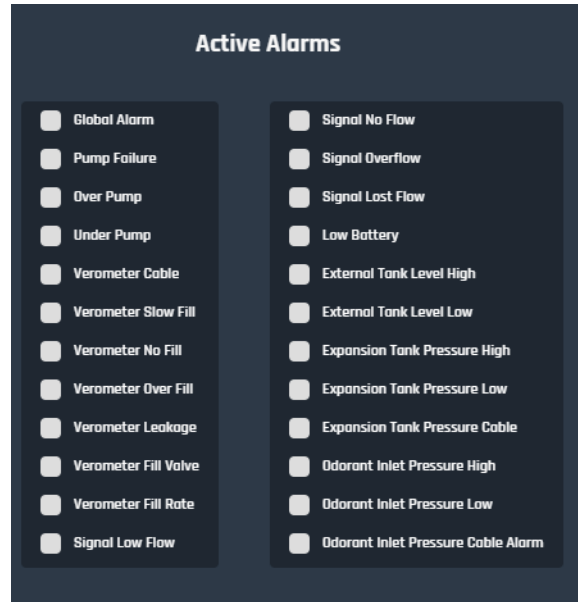

Alarm Log

View the date and time when an alarm occurred and cleared. Filter by date as necessary.

The screenshot shows a dark-themed interface titled "Alarm Log". At the top, there are filters for "From:" (12/01/2020) and "To:" (01/22/2021), along with "Options" and "Refresh" buttons. Below the filters is a table with two columns: "Time" and "Event Name".

Time	Event Name
01-14-2021 02:26:35 AM	Signal Low Flow - Cleared
01-14-2021 02:26:15 AM	Signal Low Flow
01-14-2021 01:57:15 AM	Signal Low Flow - Cleared
01-14-2021 01:33:35 AM	Signal Low Flow
01-14-2021 01:30:15 AM	Signal Low Flow - Cleared
01-14-2021 12:58:45 AM	Signal Low Flow
01-14-2021 12:33:15 AM	External Tank Level Low - Cleared
01-14-2021 12:32:25 AM	External Tank Level Low
12-18-2020 05:59:31 AM	Verometer Cable Alarm - Cleared
12-18-2020 05:59:20 AM	Verometer Cable Alarm

Event Log

View key events and when they happened. Filter by date as necessary.

The Event Log interface displays a list of events. At the top, there are filters for 'From: 06/23/2021' and 'To: 06/30/2021', along with 'Options' and 'Refresh' buttons. The events listed are:

- 06-28-2021 02:48:05 PM: SYSTEM STARTED
- 06-28-2021 02:47:55 PM: SYSTEM STOPPED
- 06-28-2021 01:43:24 PM: MODBUS COMM LOSS - CLEARED
- 06-28-2021 01:40:55 PM: MODBUS COMM LOSS
- 06-24-2021 08:38:32 AM: NJEX BACKUP SYSTEM OUTPUT - ACTIVE
- 06-23-2021 02:26:52 PM: SYSTEM STARTED
- 06-23-2021 02:25:52 PM: SYSTEM STOPPED

Change Log

View any parameter changes that were made to the unit. It will highlight the most recent parameter change by default. View the historical change log by changing the view to History. Select two historical points to compare what changed.

Last Parameter Change (default)

The Change Log interface in 'Current & Previous' view shows a bar chart with two bars at 16:00 and 16:30. Below the chart is a table of parameters:

Name	Previous	Previous
Process Type	GAS	GAS
Units	ENGLISH	ENGLISH
Mode	PROP TO FLOW	PROP TO FLOW
Flow Input	ANALOG	ANALOG
Pulse Mode	PPS	PPS
Pulses per Second	50	50
Injection Rate	1.00	1.00
Maximum gas flow	8.000	3.300
Max Inj. pump capacity	1.353	1.353
Odorant density	6.80	6.80
Prop to Time Setpoint	4.60	4.60
Flow no signal	20	20

Parameter Change History

The Change Log interface in 'History' view shows a bar chart with multiple bars between 14:00 and 16:30. Two bars are highlighted with red boxes and labeled '1st' and '2nd'. Below the chart is a table of parameters:

Name	Previous	1st
Process Type	GAS	GAS
Units	ENGLISH	ENGLISH
Mode	PROP TO TIME	PROP TO FLOW
Flow Input	ANALOG	ANALOG
Pulse Mode	PPS	PPS
Pulses per Second	50	50
Injection Rate	1.00	1.00
Maximum gas flow	3.300	8.000
Max Inj. pump capacity	0.970	1.353
Odorant density	6.80	6.80
Prop to Time Setpoint	6.60	4.60
Flow no signal	20	20

Settings

View the current settings on the N-300 or N-400 controller. The message at the top will state “Setting Changes Available” when the unit is stopped and “Stop system to make changes” if the system is running. Unit must be stopped in order to make changes.

Get Settings

Setting Changes Available

Parameter	Value	Unit
Units	English	
Media	Gas	
Mode	Prop. to Flow	
Flow Input	Analog	
Injection Rate	1.1	lb/mmcF
Pump Displacement	1.000	cc/stroke
Odorant Density	6.80	lb/gal
Prop. to Time Stroke Rate	0.02	minutes
Max Gas Flow	2.000	mmcf/hr
Low Flow Shutoff	2.0	%

Parameter	Value	Unit
Flow No Signal	20.0	%
Max time per stroke	0	Min/Stroke
Odorant Output Pulse	0.010	lb/pulse
Odorant Tank Level High	0	%
Odorant Tank Level Low	0	%
Expansion Tank Pressure High	30.0	PSI
Expansion Tank Pressure Low	20.0	PSI
Odorant Inlet Pressure High	40.0	PSI
Odorant Inlet Pressure Low	25.0	PSI

GPS

Shows the location of the odorizer. Select Map or Satellite and Zoom etc. to adjust the view. GPS can be turned off in the Hardware Parameters tab.

Parameter Value
Save

Flags

Network Time

Time Zone - Auto

Enable GPS

Hardware Parameters

An external Analog 4-20mA sensor can be connected as shown below and viewed in the “Snapshot” screen at the bottom of “General Data” under the 4-20mA Customer Sensor heading. This could be used to monitor a flow signal, odorant sensor etc. depending on the use case.

Setup:

1. Add a hole for a NEMA 4X or IP67 rated cable gland in the YZ Connect box on the same side as the Antenna cable glands (see below)
2. Run the signal wire to the YZ connect box thru the new cable gland, connect to AIN1 and GND

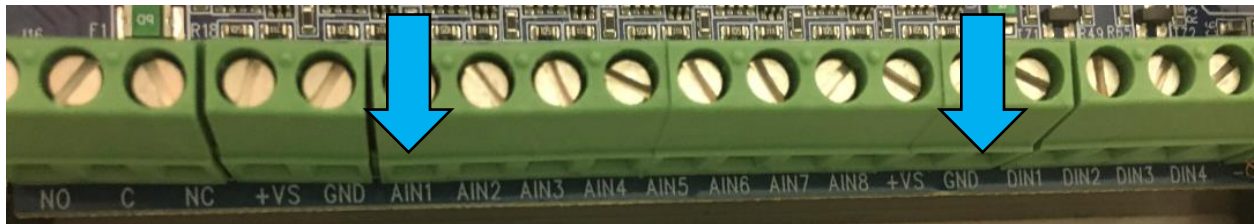

3. Setup the signal parameters in the Hardware Parameters tab
4. Enter the “Sensor Minimum” and click save
5. Enter the “Sensor Span” and click save
6. To configure, enter the min value and span, click save and then click [Device Reset](#).

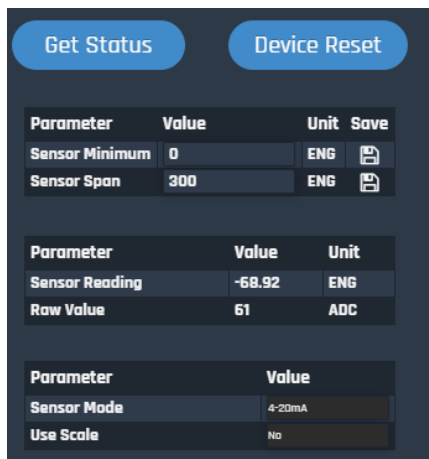
A screenshot of a web-based configuration interface. At the top, there are two buttons: "Get Status" and "Device Reset". Below them are three tables of parameters. The first table shows configuration parameters: "Sensor Minimum" with a value of 0 and unit ENG, and "Sensor Span" with a value of 300 and unit ENG. The second table shows current sensor data: "Sensor Reading" with a value of -68.92 and unit ENG, and "Raw Value" with a value of 61 and unit ADC. The third table shows device settings: "Sensor Mode" set to 4-20mA and "Use Scale" set to No.

Parameter	Value	Unit	Save
Sensor Minimum	0	ENG	
Sensor Span	300	ENG	

Parameter	Value	Unit
Sensor Reading	-68.92	ENG
Raw Value	61	ADC

Parameter	Value
Sensor Mode	4-20mA
Use Scale	No

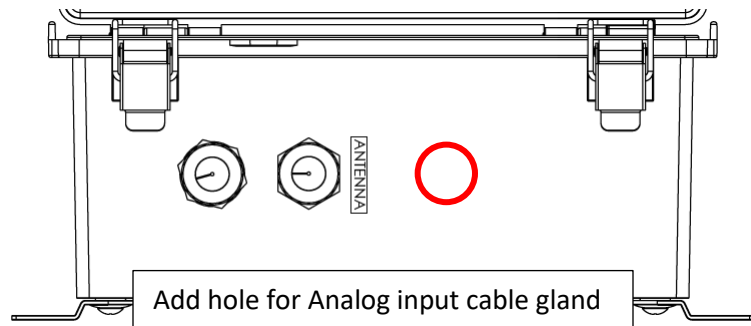

Reports

The following options exist for each odorizer

- Graph
- Tabular
- Email History
- SMS History

Graph

YZ Connect plots the data snapshots taken every 10 minutes for easy viewing. Graphs can be filtered and customized in a number of different ways:

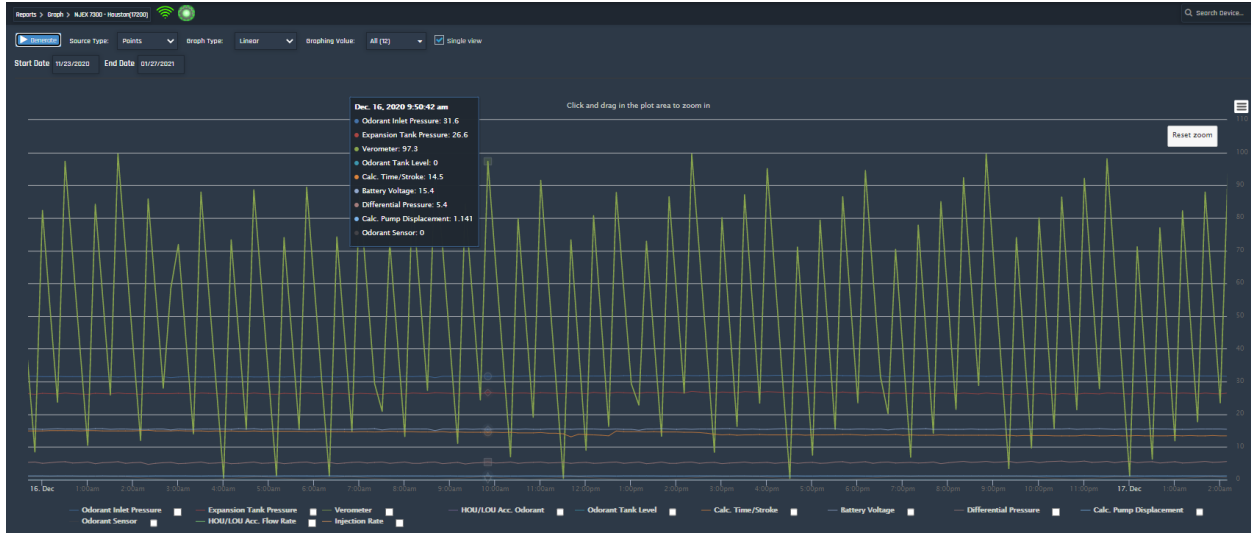

- Choose the date range to view and then click 
- Filter parameters to graph via the drop down for “Graphing Value”
- View all the data individually or in a common graph (Single view)
 - When viewing all the data in a single view:
 - Click the parameter check box to add a custom Y-scale for the parameter
 - Click on the parameter name to hide it from the graph
 - Uncheck “Single View” in the upper right to see each parameter graphed separately
- Certain parameters like total odorant injected etc. are viewed via the “Graph Type” being changed to “Accumulated”
- Click and drag on a graph to zoom in on a section of data
- Hover over a point on the graph to see the individual values at that time stamp
- Select the 3 bar icon in the upper right for download and print options:

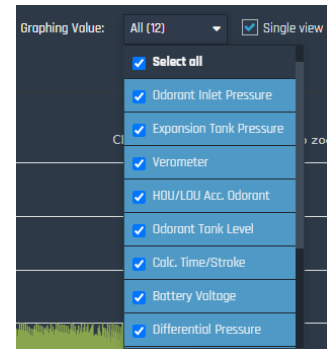
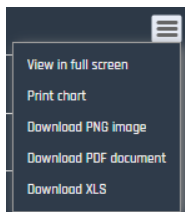

Tabular

YZ Connect data can be viewed in a table format for filtering and easy export to excel. Tables can be filtered and customized in a number of different ways:

The screenshot shows the YZ Connect web interface for generating a tabular report. At the top, the breadcrumb navigation reads "Reports > Tabular > NJEX 7300 - Houston(17200)". Below this, there is a "Generate" button and several configuration options: "Source Type" set to "Points", "Report Type" set to "Linear", and "Report Value" set to "3 selected". The "Start Date" is "11/23/2020" and the "End Date" is "01/27/2021". A "Show 25 entries" dropdown is visible. In the top right corner, there are icons for database, export, and print. The main area displays a table with the following data:

Time	Odorant Inlet Pressure	Expansion Tank Pressure	Differential Pressure
2020-12-31 11:54 PM	31.8	27.1	4.7
2020-12-31 11:44 PM	31.8	27.1	4.8
2020-12-31 11:34 PM	31.9	27.2	4.7
2020-12-31 11:24 PM	31.9	27.2	4.7
2020-12-31 11:14 PM	31.9	27.2	4.7
2020-12-31 11:04 PM	31.9	27.2	4.7
2020-12-31 10:54 PM	31.9	27.2	4.7

- Choose the date range to view and then click 
- Filter the data to view via the drop down for "Report Value"

The screenshot shows the "Report Value" dropdown menu. The current selection is "2 selected". The menu items are:

- Select all
- Odorant Inlet Pressure
- Expansion Tank Pressure
- Verometer
- HOU/LOU Acc. Odorant
- Odorant Tank Level
- Calc. Time/Stroke
- Battery Voltage
- Differential Pressure

- Export the tabular data via one of the options in the upper right



Email and SMS History

View the SMS or email alerts sent when a global alarm was triggered. User(s) who should receive the email or text notification along with any escalations must be configured - see the next section for details on setup.

Global Alarm Notifications – Email and SMS

Select users already setup in YZ Connect to get emails or text messages whenever a global alarm is triggered on the unit. Each user can have two emails and a cell phone in their user settings. Contact info is added in the user setup screen and must be done by an Admin level or higher – Primary Email, Secondary Email and Mobile Phone.

To assign the alerts, click on  icon on the Snapshot page. Select the users to be alerted when the global alarm goes on “condition set alert” or when the global alarm goes off “condition reset alert”.

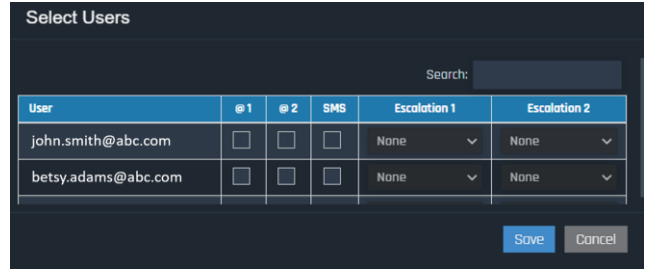
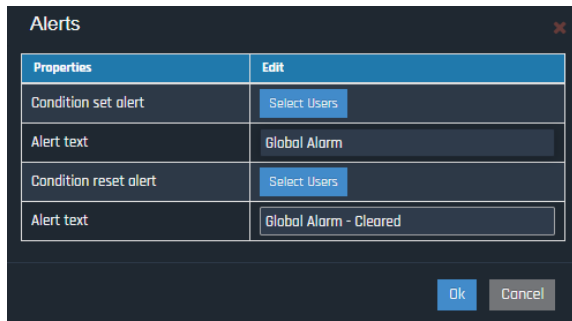

Check the users and the methods setup to alert them:

- @1 = primary email
- @2 = secondary email (if a secondary email was added for that user)
- SMS* = text message (if a cell phone number was added for that user)
- Escalation 1: select the user to escalate to if the selected user doesn't respond in 30min
- Escalation 2: select the user to escalate to if escalation 1 user doesn't respond in 30min

***In order to setup escalation 1 or 2 the user must have a cell phone number setup in YZ Connect**

Keeping an alarm from escalating:

When the user receives a text message, they can respond with the code given in the text so that it doesn't escalate to the next person.

Forcing an alarm to escalate:

When the user receives a text message, they can respond with E followed by the code (for example E123456) to force it to escalate to the next user.

SMS Alert Messages:

Without escalation enabled

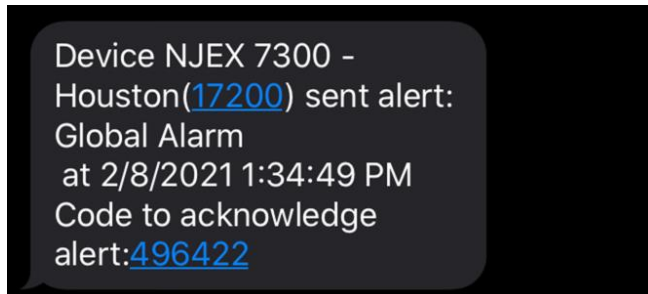

With escalation enabled

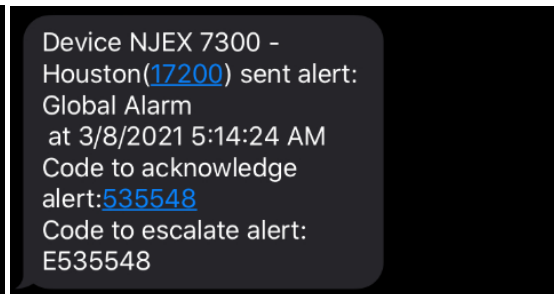

Troubleshooting

Follow the below steps to troubleshoot YZ Connect.

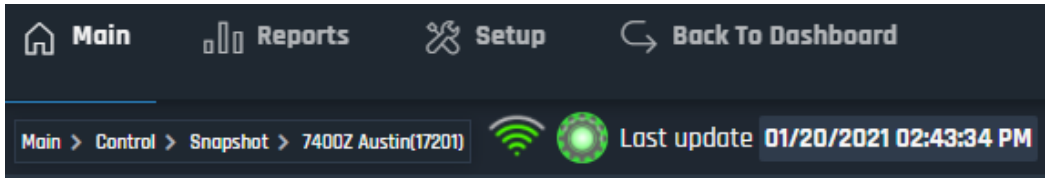

Icon Color and Signal Strength

Icon	Meaning	Action
	Indicates the device is online and communicating with the servers	-
	Indicates the device is offline and NOT communicating with the servers	Check power, call tech support for assistance if issue persists
	Modbus Communication Error	Check Modbus wiring and settings on controller
	Unit has a Global Alarm	Select this unit and view the "Alarms" tab or the "Alarm Log"
	Indicates there is a pending communication message with the device. The red outline may be there temporarily or constantly.	Check message in Download tab
	Cellular service strength indicator	If you don't see any green bars call tech support for assistance

Check Modbus Communication

On the Snapshot page for each odorizer is an LED indicator for Modbus communication. If Modbus communication is functioning it will be GREEN, if it isn't then it will be RED.



If the Modbus Comm LED is RED, do the following:

- Check the Modbus wiring is correct at the controller and the YZ Connect Box.
- Check the Modbus settings on the controller match those listed at the beginning of this manual
- Ensure the correct Modbus port (COM1 or COM2) is enabled for the controller being used. Reference the NJEX or ZEO manual if necessary.
- After making any changes, click  to see if the indicator changes color

Download Tab

If the  icon is active, a message will be available in the download tab for that device. Go to the download tab to determine the state of the pending message. This tab will show info on the cause of the failed message. To access this tab:

1. Click on your user name in the upper right-hand corner of the screen
2. Select Download
3. A list of pending downloads will be displayed
4. Select Details to view the state of the download
5. Delete Message – State 4, 5, and 6 messages can be deleted.
6. Flag the desired message from the details window and click delete.
7. The icon should now be green again without the red border

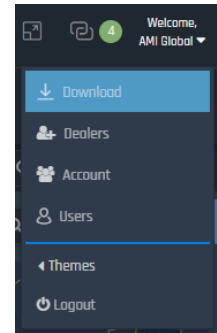

In the example below the State = 4, this indicates a Modbus communication error between the device and PLC. See the complete list of states and corresponding meaning below.

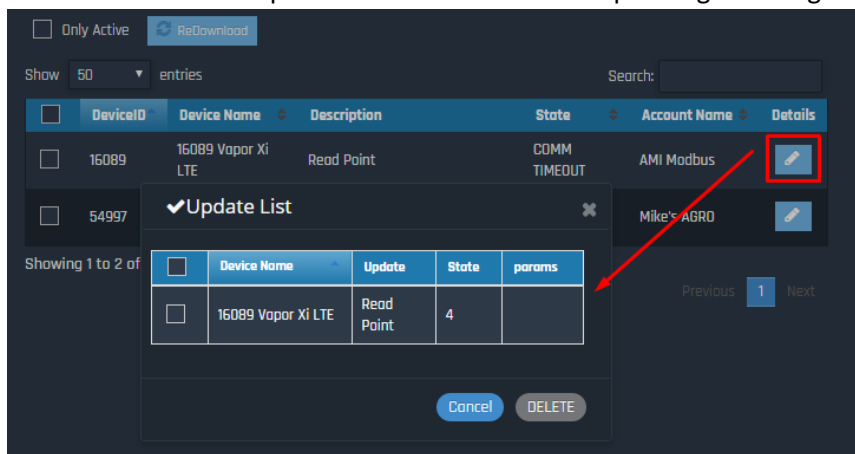
A screenshot of the 'Download' tab interface. At the top, there are checkboxes for 'Only Active' and 'ReDownload'. Below is a table with columns: DeviceID, Device Name, Description, State, Account Name, and Details. The first row shows DeviceID 16089, Device Name '16089 Vapor Xi LTE', Description 'Read Point', State 'COMM TIMEOUT', and Account Name 'AMI Modbus'. A red box highlights the 'Details' icon for this row. A modal window titled 'Update List' is open, showing a table with columns: Device Name, Update, State, and params. The table contains one row with Device Name '16089 Vapor Xi LTE', Update 'Read Point', and State '4'. There are 'Cancel' and 'DELETE' buttons at the bottom of the modal.

Download – Message States

State definitions.

- State 0 – Communication initiated
- State 1 – First attempt with sending the message
- State 2 – Second attempt with sending the message if first attempt fails.
- State 3 – Successful transmission
- State 4 – Modbus communication failure
- State 5 – Cellular communication failure

Frequently asked questions

What products are supported?

N-300 and N-400 controllers can be connected to YZ Connect.

What is the data security for YZ Connect?

YZ Connect data is AES-256 encrypted from the cellular gateway to the cloud. Cloud data is shared via secure SSL connection (same security used for online payments) to the dashboard for viewing.

Can I change my password?

Yes – click forgot password from the login screen or from the users tab.

Do I have to change my password?

Yes – The system will require users to change their password from time to time. This is an added security measure to control system access.

Why am I prompted to enter a code when logging in on a new device?

This is because we use 2-factor authentication to protect the logins of our users. If it's the 1st time logging in on a device then YZ Connect will prompt the user for a code sent to the user logging in.

Why does my device icon look grey?

The grey icon means that the device is not connected to the servers. This could be caused by several reasons; power, low or no cell signal, service has been deactivated, or installed in an area that block cellular signal.

What does the red outline around the device icon mean?

The red outline means that there is a pending message or command with the device. The most common reason for this icon is a Modbus communication failure which will typically correct itself if it has been functioning. If the red outline does not go away after 30 minutes, contact tech support.

Is there a mobile app?

There is a mobile app for Android and iOS devices; search YZ Connect in the respective app store.

APPENDIX A – Panel Control Drawing

	1	2	3	4	5																		
A	HAZARDOUS AREA		NON-HAZARDOUS AREA																				
	CLASS 1, DIV 1, GROUPS C-D OR CLASS 1, ZONE 1, GROUP IIB OR ZONE 0, GROUP IIB																						
B	<p style="text-align: center;">INTRINSICALLY SAFE WIRING BARRIER: G.M. INTERNATIONAL D1061S-077</p> <p style="text-align: center;">3/8" NPT GLAND CONNECTION</p> <table border="1" style="width: 100%; border-collapse: collapse;"> <tr> <th style="width: 50%;">SIGNAL</th> <th style="width: 50%;">BARRIER TERMINAL</th> </tr> <tr> <td>RS485-</td> <td>13</td> </tr> <tr> <td>RS485+</td> <td>14</td> </tr> <tr> <td>SHIELD (OPT)</td> <td>10</td> </tr> </table>		SIGNAL	BARRIER TERMINAL	RS485-	13	RS485+	14	SHIELD (OPT)	10													
SIGNAL	BARRIER TERMINAL																						
RS485-	13																						
RS485+	14																						
SHIELD (OPT)	10																						
C	<p style="text-align: center;">AC WIRING IN</p> <p style="text-align: center;">115/230VAC, 0.55/0.35A, 50/60Hz</p> <p style="text-align: center;">1/2" FLEXIBLE CONDUIT FITTING</p> <p style="text-align: center;">1.3 mm² (16 AWG) WIRE SIZE, 5 kgf-cm (4.4 lb-in) TORQUE REQUIRED</p> <table border="1" style="width: 100%; border-collapse: collapse;"> <tr> <th style="width: 50%;">WIRE</th> <th style="width: 50%;">TERMINAL</th> </tr> <tr> <td>LINE</td> <td>L</td> </tr> <tr> <td>NEUTRAL</td> <td>N</td> </tr> <tr> <td>GROUND</td> <td>133.B</td> </tr> </table>		WIRE	TERMINAL	LINE	L	NEUTRAL	N	GROUND	133.B													
WIRE	TERMINAL																						
LINE	L																						
NEUTRAL	N																						
GROUND	133.B																						
D	<p>NOTES:</p> <ol style="list-style-type: none"> BARRIER/ISOLATOR PARAMETERS: $U_o = 3.7V$, $I_o = 93mA$, $P_o = 85mW$ MAXIMUM EXTERNAL PARAMETERS GROUP IIB: $C_o/C_a = 1000\mu F$, $L_o/L_a = 16.7mH$, $L_o/R_o = 1690.9\mu H/\Omega$ SEE THE CONTROL DRAWING FOR EACH INTRINSIC SAFETY BARRIER FOR PERMITTED CONNECTIONS AND IDENTIFICATION OF THE ELECTRICAL (ENTITY) PARAMETERS OF EACH BARRIER, ALONG WITH OTHER INFORMATION FOR SAFE INTERCONNECTION. AMBIENT TEMPERATURE RANGE -4F - 140F (-20C - 60C). INSTALL IN ACCORDANCE WITH THE NATIONAL ELECTRICAL CODE (NEC) AND ANY APPLICABLE LOCAL CODES IN WHICH THE EQUIPMENT IS LOCATED. CABLE LENGTH FOR INTRINSICALLY SAFE RS485 SIGNAL: $\leq 1200M$ UP TO 93.75 Kbit/s, $\leq 1000m$ UP TO 187.5 Kbit/s, $\leq 400M$ UP TO 500 Kbit/s, $\leq 200M$ UP TO 1.5 Mbit/s. TERMINAL SIZE IS 2.5 MM² (14AWG). WIRING BETWEEN IS EQUIPMENT AND RS485 BARRIER MUST HAVE A MINIMUM INSULATION THICKNESS OF 0.25MM. BARRIER IS INTENDED FOR CONNECTING ONLY TO PURELY RESISTIVE, NON-ENERGY STORING DEVICES. 8 MINIMUM COMPONENT SPACINGS ARE SHOWN FOR THE COMPONENTS ABOVE TO ENSURE MINIMUM SPACINGS ARE MAINTAINED BETWEEN NON-INTRINSICALLY SAFE CIRCUITS AND INTRINSICALLY SAFE CIRCUITS AND OPPOSITE POLARITIES OF PROTECTIVE COMPONENTS. 9 ALL INTERNAL COMPONENTS CONSIDERED DEAD METAL PARTS ARE FACTORY SUPPLIED CONNECTING THE EQUIPMENT TO THE GROUNDING TERMINAL. CUSTOMER MUST PROVIDE 1.3mm² (16AWG) WIRE AS SHOWN ABOVE. SCHEDULE DRAWING - NO CHANGES CAN BE MADE TO THIS DRAWING OR THE SPECIFICATIONS LISTED ABOVE WITHOUT PRIOR AGENCY APPROVAL. SEE DRAWING 1A-0477 FOR RELATED DRAWING (FACTORY ACCESSIBLE ONLY). 																						
E																							
F																							
	<table border="1" style="width: 100%; border-collapse: collapse;"> <tr> <td style="width: 15%;">7/8/2021</td> <td style="width: 15%;">26635</td> <td style="width: 30%;">ADDED MAX EXTERNAL PARAMETERS TO NOTE 1</td> <td style="width: 15%;">TRA</td> <td style="width: 15%;">SPH</td> <td style="width: 10%;">01</td> </tr> <tr> <td>4/26/2021</td> <td>25924</td> <td>INITIAL RELEASE</td> <td>TRA</td> <td>SPH</td> <td>00</td> </tr> <tr> <td>DATE</td> <td>ECN</td> <td>DESCRIPTION</td> <td>Drawn - Dessiné / Visa</td> <td>Checked -Vérifié / Visa</td> <td>REV</td> </tr> </table>					7/8/2021	26635	ADDED MAX EXTERNAL PARAMETERS TO NOTE 1	TRA	SPH	01	4/26/2021	25924	INITIAL RELEASE	TRA	SPH	00	DATE	ECN	DESCRIPTION	Drawn - Dessiné / Visa	Checked -Vérifié / Visa	REV
7/8/2021	26635	ADDED MAX EXTERNAL PARAMETERS TO NOTE 1	TRA	SPH	01																		
4/26/2021	25924	INITIAL RELEASE	TRA	SPH	00																		
DATE	ECN	DESCRIPTION	Drawn - Dessiné / Visa	Checked -Vérifié / Visa	REV																		
G	<table border="1" style="width: 100%; border-collapse: collapse;"> <tr> <td rowspan="3" style="width: 25%; font-size: 8px;"> PROPRIETARY NOTICE THIS DRAWING CONTAINS CONFIDENTIAL AND TRADE SECRET INFORMATION. IS THE PROPERTY OF INGERSOLL-RAND CO., AND IS GIVEN TO THE RECEIVER IN CONFIDENCE. THE RECEIVER BY RECEPTION AND RETENTION OF THE DRAWING ACCEPTS THE DRAWING IN CONFIDENCE AND AGREES THAT, EXCEPT AS AUTHORIZED IN WRITING BY INGERSOLL-RAND CO., IT WILL (1) NOT USE THE DRAWING OR ANY COPY THEREOF OR THE CONFIDENTIAL OR TRADE SECRET INFORMATION THEREIN; (2) NOT COPY THE DRAWING; (3) NOT DISCLOSE TO OTHERS EITHER THE DRAWING OR THE CONFIDENTIAL OR TRADE SECRET INFORMATION THEREIN; AND (4) UPON COMPLETION OF THE NEED TO RETAIN THE DRAWING, OR UPON DEMAND, RETURN THE DRAWING, ALL COPIES THEREOF, AND ALL MATERIAL COPIED THEREFROM. </td> <td style="width: 15%; font-size: 8px;"> GENERAL TOLERANCE ISO2768-MK TOLERANCES mm [INCHES] ±0.1[.004] ±0.2[.008] ±0.3[.012] ±0.5[.020] ±0.6[.031] ±1.2[.047] ±2[.079] </td> <td style="width: 45%; font-size: 8px;"> REVISION HISTORY LINEAR DIMENSIONS - DIMENSIONS LINÉAIRES mm[INCHES] Ra FINISH GEOMETRIC TOLERANCES TOLERANCES GÉOMÉTRIQUES 12.5_{FORM} </td> <td style="width: 15%; font-size: 8px;"> MILTON ROY </td> </tr> <tr> <td colspan="4" style="text-align: center; font-size: 12px;"> PANEL CONTROL DOC YZ CONNECT F2-0256 </td> </tr> <tr> <td style="font-size: 8px;"> FORMAT TAILLE A4 </td> <td style="font-size: 8px;"> FIRST ANGLE PROJECTION </td> <td style="font-size: 8px;"> SHEET - FEUILLE 1 / 1 DO NOT SCALE DRAWING DESSIN SANS ECHELLE </td> <td style="font-size: 8px;"> DRAWING NUMBER - PLAN N° 1E-0388 REV 01 </td> </tr> <tr> <td colspan="5" style="font-size: 8px; text-align: center;"> WARNING: THE EXPORT OR REEXPORT OF THIS DRAWING OR A PRODUCT PRODUCED BY THIS DRAWING IS SUBJECT TO U.S. EXPORT ADMINISTRATION REGULATIONS AND OTHER APPLICABLE GOVERNMENT RESTRICTIONS OR REGULATIONS </td> </tr> </table>					PROPRIETARY NOTICE THIS DRAWING CONTAINS CONFIDENTIAL AND TRADE SECRET INFORMATION. IS THE PROPERTY OF INGERSOLL-RAND CO., AND IS GIVEN TO THE RECEIVER IN CONFIDENCE. THE RECEIVER BY RECEPTION AND RETENTION OF THE DRAWING ACCEPTS THE DRAWING IN CONFIDENCE AND AGREES THAT, EXCEPT AS AUTHORIZED IN WRITING BY INGERSOLL-RAND CO., IT WILL (1) NOT USE THE DRAWING OR ANY COPY THEREOF OR THE CONFIDENTIAL OR TRADE SECRET INFORMATION THEREIN; (2) NOT COPY THE DRAWING; (3) NOT DISCLOSE TO OTHERS EITHER THE DRAWING OR THE CONFIDENTIAL OR TRADE SECRET INFORMATION THEREIN; AND (4) UPON COMPLETION OF THE NEED TO RETAIN THE DRAWING, OR UPON DEMAND, RETURN THE DRAWING, ALL COPIES THEREOF, AND ALL MATERIAL COPIED THEREFROM.	GENERAL TOLERANCE ISO2768-MK TOLERANCES mm [INCHES] ±0.1[.004] ±0.2[.008] ±0.3[.012] ±0.5[.020] ±0.6[.031] ±1.2[.047] ±2[.079]	REVISION HISTORY LINEAR DIMENSIONS - DIMENSIONS LINÉAIRES mm[INCHES] Ra FINISH GEOMETRIC TOLERANCES TOLERANCES GÉOMÉTRIQUES 12.5 _{FORM}	MILTON ROY	PANEL CONTROL DOC YZ CONNECT F2-0256				FORMAT TAILLE A4	FIRST ANGLE PROJECTION 	SHEET - FEUILLE 1 / 1 DO NOT SCALE DRAWING DESSIN SANS ECHELLE	DRAWING NUMBER - PLAN N° 1E-0388 REV 01	WARNING: THE EXPORT OR REEXPORT OF THIS DRAWING OR A PRODUCT PRODUCED BY THIS DRAWING IS SUBJECT TO U.S. EXPORT ADMINISTRATION REGULATIONS AND OTHER APPLICABLE GOVERNMENT RESTRICTIONS OR REGULATIONS					
PROPRIETARY NOTICE THIS DRAWING CONTAINS CONFIDENTIAL AND TRADE SECRET INFORMATION. IS THE PROPERTY OF INGERSOLL-RAND CO., AND IS GIVEN TO THE RECEIVER IN CONFIDENCE. THE RECEIVER BY RECEPTION AND RETENTION OF THE DRAWING ACCEPTS THE DRAWING IN CONFIDENCE AND AGREES THAT, EXCEPT AS AUTHORIZED IN WRITING BY INGERSOLL-RAND CO., IT WILL (1) NOT USE THE DRAWING OR ANY COPY THEREOF OR THE CONFIDENTIAL OR TRADE SECRET INFORMATION THEREIN; (2) NOT COPY THE DRAWING; (3) NOT DISCLOSE TO OTHERS EITHER THE DRAWING OR THE CONFIDENTIAL OR TRADE SECRET INFORMATION THEREIN; AND (4) UPON COMPLETION OF THE NEED TO RETAIN THE DRAWING, OR UPON DEMAND, RETURN THE DRAWING, ALL COPIES THEREOF, AND ALL MATERIAL COPIED THEREFROM.	GENERAL TOLERANCE ISO2768-MK TOLERANCES mm [INCHES] ±0.1[.004] ±0.2[.008] ±0.3[.012] ±0.5[.020] ±0.6[.031] ±1.2[.047] ±2[.079]	REVISION HISTORY LINEAR DIMENSIONS - DIMENSIONS LINÉAIRES mm[INCHES] Ra FINISH GEOMETRIC TOLERANCES TOLERANCES GÉOMÉTRIQUES 12.5 _{FORM}	MILTON ROY																				
	PANEL CONTROL DOC YZ CONNECT F2-0256																						
	FORMAT TAILLE A4	FIRST ANGLE PROJECTION 	SHEET - FEUILLE 1 / 1 DO NOT SCALE DRAWING DESSIN SANS ECHELLE	DRAWING NUMBER - PLAN N° 1E-0388 REV 01																			
WARNING: THE EXPORT OR REEXPORT OF THIS DRAWING OR A PRODUCT PRODUCED BY THIS DRAWING IS SUBJECT TO U.S. EXPORT ADMINISTRATION REGULATIONS AND OTHER APPLICABLE GOVERNMENT RESTRICTIONS OR REGULATIONS																							
	1	2	3	4	5																		